



Measuring Seepage Losses from Canals Using the Ponding Test Method



Eric Leigh and Guy Fipps*

Seepage losses from canals can be significant. The Texas AgriLife Extension Service has measured seepage loss rates ranging from 23 to 1,690 acre-feet per mile (per year) in the Lower Rio Grande Valley of Texas (see Table 1). Measuring seepage loss rates is one of the best ways to prioritize canals for maintenance and rehabilitation and determine the effectiveness of canal improvements quantified through pre- and post-rehabilitation testing.

Table 1. Results of canal seepage loss tests in the Lower Rio Grande River Basin.

Test ID	Width (ft)	Depth (ft)	Loss rate	
			gal/ft ² /day	ac-ft/mi/yr
Lined				
LF1	12	5	1.77	152.9
LF2	10	6	4.61	369.1
MA4	12	5	8.85	529.7
SJ4	15	4	1.17	111.2
SJ5	14	5	1.38	145.5
UN1	12	6	2.32	217.7
UN2	8	3	2.09	121.2
Unlined				
BR1	60	11	3.14	794.6
MA3	19	5	13.9	1690.1
RV1	38	4	0.15	23.0
SB4	16	4	0.64	68.3
SB5	18	3	1.67	188.3
SB6	20	5	1.44	189.0
SB7	16	4	0.42	47.4
SB8	20	5	0.83	104.0

*Extension Associate and Professor and Extension Agricultural Engineer, The Texas A&M System.

There are several methods of estimating and measuring seepage losses from canals. One way is to use typical seepage loss rates such as those shown in Tables 1 and 2, combined with your “best professional judgment” on the condition of the particular canal. Another method involves measuring the flow in a canal at an upstream and downstream location and attributing any flow reductions to seepage loss. The accuracy of this method depends on the type of flow meter and measuring technique used, the size of the canal and the volume of water.

Table 2. Canal seepage rates reported in published studies.

Lining/Soil type	Seepage rate (gal/ft ² /day)
Unlined ¹	2.21-26.4
Portland cement ²	0.52
Compacted earth ²	0.52
Brick masonry lined ³	2.23
Earthen unlined ³	11.34
Concrete ⁴	0.74 - 4.0
Plastic ⁴	0.08-3.74
Concrete ⁴	0.06-3.22
Gunite ⁴	0.06-0.94
Compacted earth ⁴	0.07-0.6
Clay ⁴	0.37-2.99
Loam ⁴	4.49-7.48
Sand ⁴	4.0-19.45

¹DeMaggio(1990)

²U.S. Bureau of Reclamation (1963)

³Nayak, et al. (1996)

⁴Nofziger (1979)

The Ponding Test Method

The ponding test method is considered to be the most accurate, and is often used as the standard of comparison for other methods. In this method two ends of a

canal segment are closed or sealed (usually with earthen dams) to create a ponded pool of water (Fig. 1). The change in water level is measured over 24 to 48 hours and used along with the canal dimensions to calculate the seepage loss rate for the canal.

Ponding tests are classified as either “seepage loss tests” or “total loss tests” depending on the characteristics of the canal segment and the presence of leaking valves, gates and other structures.

Seepage loss tests measure the seepage losses through the bottoms and sides of canals. Short canal segments are often used to avoid valves, gates or other structures that can leak. Thus, all water loss is due to seepage through a canal’s bottom and sides.

Total loss tests are conducted in canal segments that contain valves, gates and other structures that might contribute to the losses measured. It may be important to account for losses from leaky control structures when considering canal improvements, but these types of leaks are often hard to notice and difficult to measure separately from canal seepage (Fig. 2).



Figure 2.

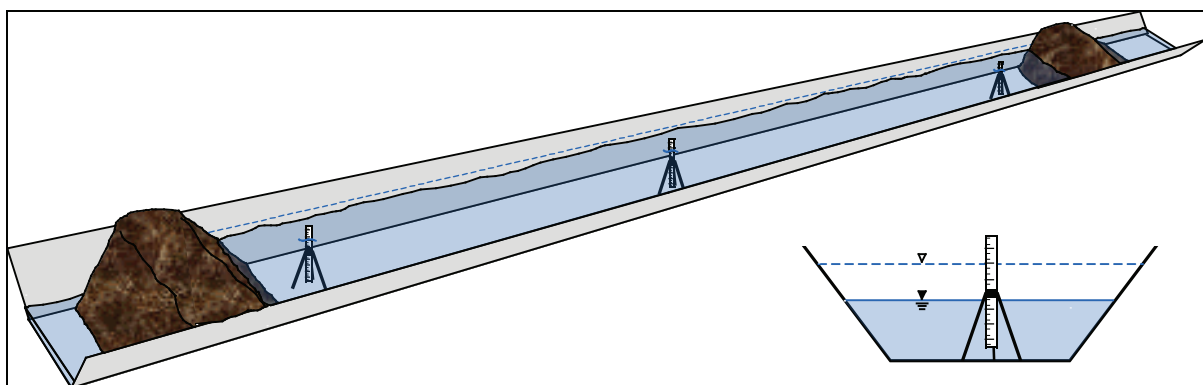

Figure 1. Ponding test.

Factors Affecting Water Loss

Many factors can affect seepage and total water losses in canals. Documenting and recording these factors can help in selecting canals and comparing test results.

- Soil type—texture, compaction and permeability (or infiltration rate)
- Type and condition of lining material—permeability, condition (size and number of cracks), erosion, construction methods, etc.
- Control structures—leaks through wooden gates and rusty and/or broken steel valves
- Wildlife—holes and erosion caused by animal traffic and rodents
- Shallow groundwater table—depth to groundwater
- Sedimentation—Silt can help seal the canal bottom, but breaking the silt seal on unlined canals during reshaping and routine maintenance increases seepage.
- Evaporation—temperature, wind speed, relative humidity, wind blocks, etc.
- Trees and plants—
 - Roots can crack a canal lining and create holes through canal levees.
 - Plant transpiration accounts for some loss.
- Routine maintenance—
 - Cleaning out and reshaping unlined canals can often break the seal caused by sedimentation.
 - Heavy machinery used to clean out lined canals can crack the concrete.
- Length of time the canal has been in operation before testing—level of saturation and absorption of water into canal walls
- Depth of water in canal—Generally, the higher the water level, the higher the losses.

Selecting the Canal for a Ponding Test

The selection process can be as easy or as complex as you want to make it. In most cases, canals are pre-selected for testing because of known problems and rehabilitation plans. A more systematic approach is to rank canals using certain parameters (Table 3).

Table 3. Important parameters for prioritizing canals for testing.

Canal type

Earthen

- Construction preparation and methods used
- Material type of levee
- Compaction
- Soil type inside the canal
- Erosion

Lined

- Construction preparation and methods used
- Material type of levee
- Compaction
- Type of lining materials
- Size and frequency of cracks
- Current condition
 - Visible leaks
 - Water and vegetation in drain ditch
 - Vegetation
- Annual use/Area served

Canal construction

Any documentation on the original construction methods used will be helpful. Unlined canals obviously have higher seepage rates in more porous soils. Canals built in clay soils or with clay linings may be subjected to shrinking and swelling, which can cause cracks in the canal floor if the canal is allowed to dry out.

Unreinforced concrete/shotcrete is more apt to crack and break in a shorter period of time. A synthetic membrane under-liner can reduce or eliminate seepage, but if the synthetic liner is improperly installed and then covered with concrete/shotcrete, the liner may tear and cause continual seepage. An exposed lining material can be vulnerable to cuts, holes and abrasions from many sources.

Soils

In unlined canals, seepage losses often are proportional to soil texture, with sandy soils having higher loss rates than clays. If there is no documentation of the soils used in construction, general soil series maps can be helpful in identifying canal segments with higher seepage rates, as canals usually are constructed with surrounding materials. These maps are available from the USDA Natural Resources Conservation Service.

Canal condition

While appearances can be deceiving, it is often true that the worst looking canal will have the highest loss rate. Visually rating the condition of canals can help you

prioritize them for testing. In our studies, the characteristics and numerical rating scales in Table 4 have accurately predicted the magnitude of seepage loss rates of canals.

Other indicators of significant water loss include year-round aquatic vegetation and standing water in the drainage system, large stands of vegetation around or on canal levees, and cropland adjacent to canals that has become waterlogged or salted out because of a rising water table level.

Current and future use

Other factors in selecting test canals involve current water usage in the district and how that is expected to change over time. Priority is usually given to those areas that have the most annual water use and that are expected to stay in production for years to come.

5. Consult soil maps to select an area representative of a certain soil type.
6. Choose areas accessible to trucks and other vehicles used for testing or constructing the test sections.
7. Check the levee for leaks from large holes and cracks that are not representative of the test segment, unless your intent is to specifically measure this problem area.
8. Generally, the longer the test section, the better; 600 feet long is typical. However, it is better to shorten the length of the segment than to include sections with gates and valves. If such control structures cannot be avoided, seal and back-fill with soil around the structure to minimize leakage.

Table 4. Canal rating by observation.

<p>General condition</p> <ol style="list-style-type: none"> 1. Excellent 2. Good 3. Fair 4. Poor 5. Serious problems 	<p>(Vegetation)</p> <p>Aquatic vegetation growing from bottom</p> <ul style="list-style-type: none"> • % aquatic vegetation in water (based on length of section rated) • Types of aquatic vegetation in water <p>Canal sidewall lining – vegetation growing in canal lining</p> <ol style="list-style-type: none"> 0. None 1. Sparse 2. Moderate 3. Dense <p>Drainage ditch – vegetation in drainage ditch and along the outer level embankment base</p> <ol style="list-style-type: none"> 0. None 1. Normal; rain-fed weeds only 2. Moderate; bushes and some trees (no water) 3. Dense; more bushes and larger trees and/or standing water with little or no aquatic vegetation 4. Dense and lush; bushes, trees and/or lots of aquatic vegetation with standing water
<p>(Only for lined canals)</p> <p>Cracks/holes – size/frequency</p> <ul style="list-style-type: none"> • Hairline • Pencil-size • Large <p><u>Rating scale</u></p> <ol style="list-style-type: none"> 0. None 1. Sparse 2. More than 10 feet apart 3. 5 feet to 10 feet apart 4. 3 feet to 5 feet apart 5. Less than 3 feet apart 	

Selecting the Test Segment

The next step is to select the specific canal segment for testing, using the following guidelines:

1. Avoid curves and select straight canal sections.
2. Avoid sections on steep slopes.
3. For seepage loss tests, avoid segments containing turnouts, valves, gates and other flow control structures.
4. Select segments with minimal changes in canal dimensions (i.e., width, depth, etc.).
9. Beware of areas that might be vandalized easily to avoid damage to equipment and dams; or provide security 24 hours a day.

Planning: Have you thought about...

- When can the canal be shut down?
- How long can the canal be shut down? (A test usually requires at least 3 days.)
- Who will this affect?
- Do I need to tell or send out notices to the users (farmers)?
- How much time in advance will I need to send out the notices?
- Is maintenance needed on the test segment? (For example, mowing and trimming the grass and plants on at least one side of the canal levee will make it easier when surveying and recording water levels. See Figure 3.)



Figure 3.

Preparing for the Test

Measuring and flagging the test segment



Figure 4.

Use a measurement wheel or survey instrument to measure the length of the test segment (Fig. 4). Determine the staff gauge locations and place flag markers or stakes at the locations of the dams and the staff gauges (Figs. 5 and 6).

Staff gauges

Staff gauges are placed in the canal test segment to measure the fall in water level during the test. Use a minimum of three staff gauges. Space them evenly throughout the test segment, or place one in the center and two at the ends located at least 20 feet from the dams.

The longer the test segment, the more staff gauges you should use. Using several will help you compare and evaluate readings and will reduce errors in the event a staff gauge should fall over or be moved.



Figure 5.



Figure 6.

Leaks and holes

Walk the test segment and check both sides of the canal levee for leaks from large holes and cracks, valves and gates. When conducting total loss tests, if a leak is not representative of the test section, try to fill it in with soil or seal it some other way. Usually a bucket or two of dirt from a backhoe will be sufficient. Smaller leaks can be filled in with shovels using the surrounding soil from the levee. Note any leaks on the test data form and record whether you needed to seal them.

Dam Construction

While clay soils are desirable, the type of soil used for constructing the dams is usually determined by availability and location. Some water districts prefer to have

the soil brought in by truck (Fig. 7), while others will use a backhoe and take it directly from the canal levee (Fig. 8). This should be done only when there is an adequate amount of soil so as to not cause damage.



Figure 7.



Figure 8.

Dams can be built with or without water in the canal. When the canal is full of water, more soil is usually needed to build the dam because the soil spreads out as it falls through the water column. This is especially true in a deep canal. Don't completely drain the canal. Having some water in the canal during construction of the dams helps saturate and stabilize them.

As the dams are built up, the soil should be compacted with a backhoe (Fig. 9), taking care not to push away uncompacted soil. Compaction will help reduce water movement through the dam and provide better stability. No matter how good the compaction is, some water will probably seep through the dams. To prevent this, cover the interior sides of the dams with 4- to 8-mil sheets of plastic.



Figure 9.

The size of the dams should be proportional to the size of the canal. The water pressure on the dams will be significantly greater in deeper canals. The tops of the finished dams should be at least 2 feet higher than the testing water depth. Dams should be at least 3 feet wide and stable enough to walk on. If you don't feel safe walking across the dam, it is not finished.

Measurement Equipment and Installation

To measure the changes in water level you will need to manually read staff gauges and/or electronic water level sensors. While there are advantages and disadvantages to both, we suggest always using staff gauges even if other devices are used. The staff gauge provides a quick and easy visual indicator of water level and is often more reliable than electronic sensors. Most districts have a limited opportunity to perform tests and you don't want to get to the end of the test and realize you have no usable data.

Staff gauges are available in a variety of styles and materials. Use ones with large numbers and line markers that are easy to see from a distance. Figure 10 shows a staff gauge scaled to 0.01 foot.

Electronic water level sensors, such as pressure transducers and float and pulley encoders, can be programmed to record measurements at set intervals throughout the testing period. This reduces manpower and the number of trips to the testing site. Disadvantages include the cost (\$500 or more per sensor and data logger) and the possibility of power failure, programming errors, vandalism and theft.



Figure 10.

When constructing or buying stands for the staff gauges, be sure they are heavy enough to withstand some water movement but not too heavy. Figure 11 shows a simple tripod stand that is easy to construct and performs very well in both lined and unlined canals. Stainless steel is a good material for stands that will be used often.



Figure 11.

When placing the measurement equipment in the canal, be sure it is stable. Avoid areas where the canal bottom is uneven or has debris that will cause the staff gauge stand to be unsteady. It is not necessary to put the staff gauge

in the center of the canal, just make sure that the markings will cover the full change in the water level. Waders or a small boat may be useful during installation (Fig. 12). After the staff gauge stand is set, use a small bubble level to level the staff gauge (Figs. 13 and 14).



Figure 12.

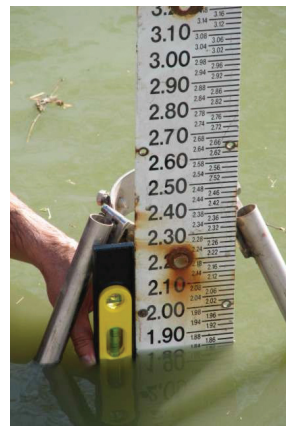

Figure 13.



Figure 14.

One or more rain gauges should be placed along the test section to measure any rain that falls during the test. The amount of rainfall is subtracted from the staff gauge readings.

Canal Measurements and Shapes

Measure the canal dimensions at every staff gauge location. Also take measurements to determine the relationship between the staff gauge readings and the actual depth of the canal (Fig. 15).

Measuring or surveying can be done before the canal water level is raised or after the test is completed and the water has drained. When taking measurements after the test, be sure to dismantle the downstream dam slowly to

prevent high flow rates that could move the staff gauge stands.

Canal measurements are taken to define its shape. Then water loss can be calculated using one of two methods:

Method 1 – basic shapes. The cross-section of the canal was originally built using one of these common shapes: rectangular, trapezoidal, triangular or parabolic. Measure the basic canal cross-sectional dimensions, including the top width, depth, side slopes and bottom width, as illustrated in Figures 16-19. Determine which shape best represents the canal. Over time, earthen (unlined) canals will likely take on a parabolic shape.

Method 2 – irregular shapes. For irregularly shaped or eroded canals, or if it is difficult to determine canal shape or take the standard dimensions, more elaborate surveying techniques must be used. One method is to

determine the top width of the canal, then take depth measurements every 1 to 2 feet as shown in Figure 20. Alternatively, ten depth measurements can be taken at equal spacings across the canal. These depth-width measurements are then used to create a cross-sectional profile. Spanning and staking a tape measure across the top of the canal will help measure the distance from each surveyed point, and will also help to keep your surveyed points in a straight line.

Filling the Test Segment

After the downstream dam is in place, there are two methods for establishing the pond:

1. Raise the water level in the test segment to the desired level, usually the normal or maximum operating level. Then build the upstream dam.
2. Build the upstream dam, then use portable pumps to fill the test segment, or begin pumping while the upstream dam is being built (Fig. 21).

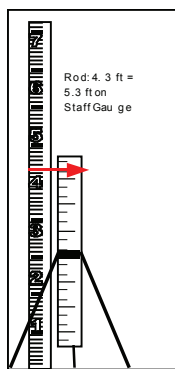

Figure 15. A staff gauge being referenced in accordance with actual water level of the canal.

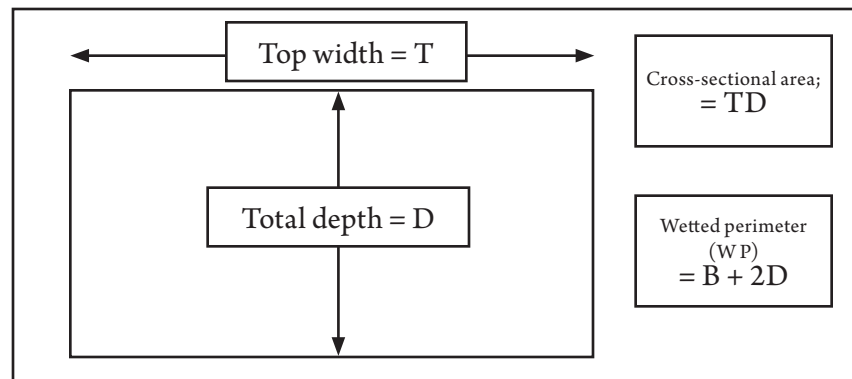

Figure 16. Rectangular cross section, basic dimensions and area equation.

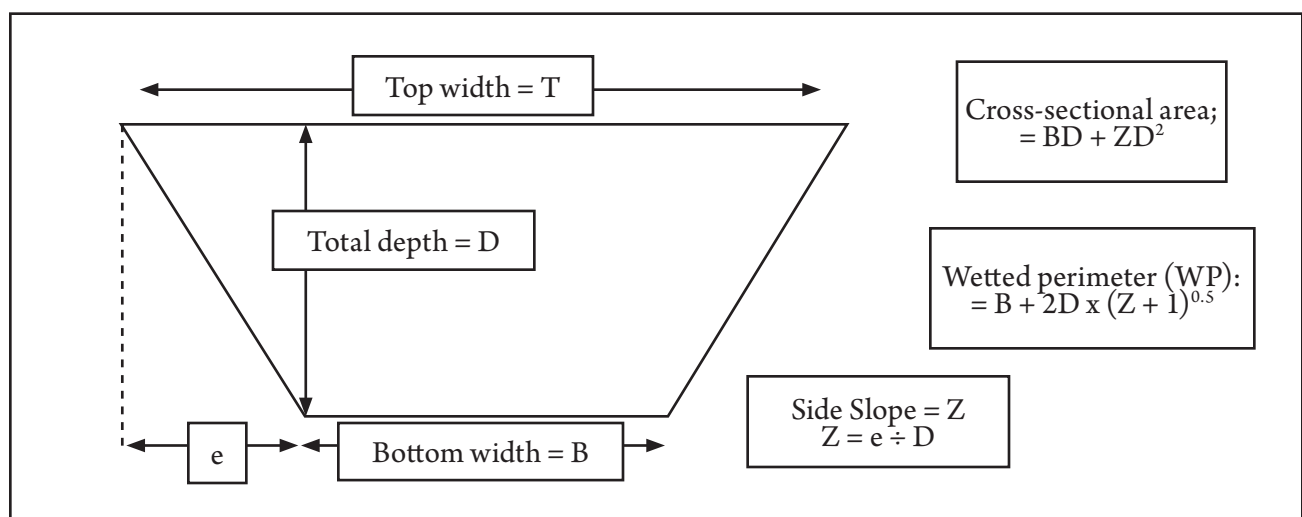

Figure 17. Trapezoidal cross section, basic dimensions and area equation.

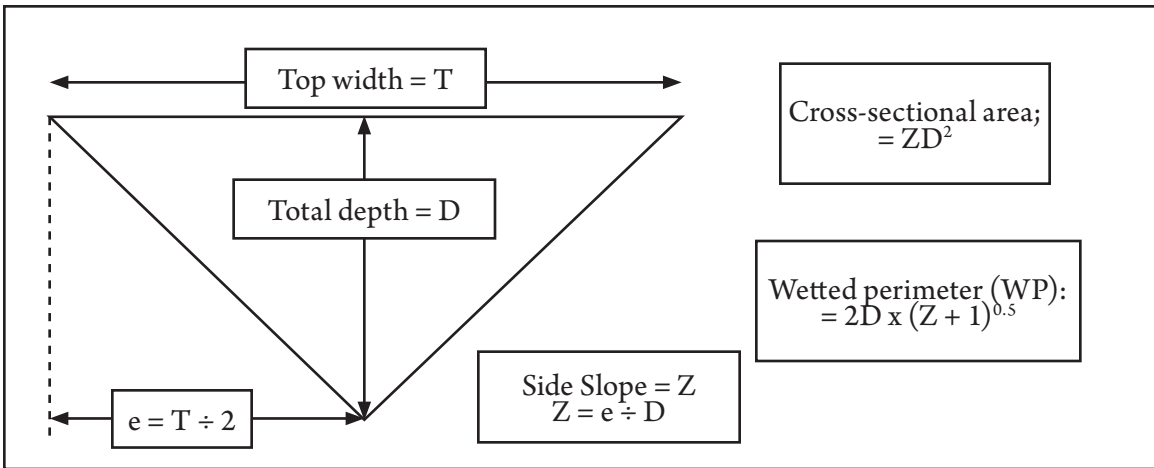

Figure 18. Triangular cross section, basic dimensions and area equation.

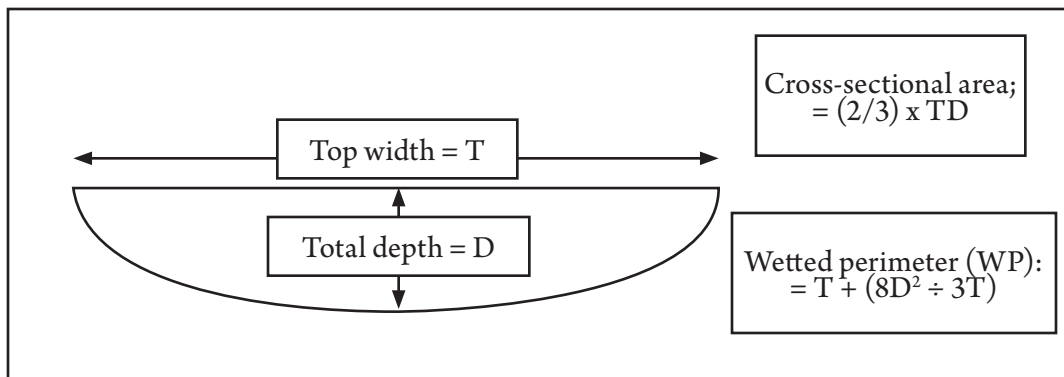

Figure 19. Parabolic cross section, basic dimensions and area equation.

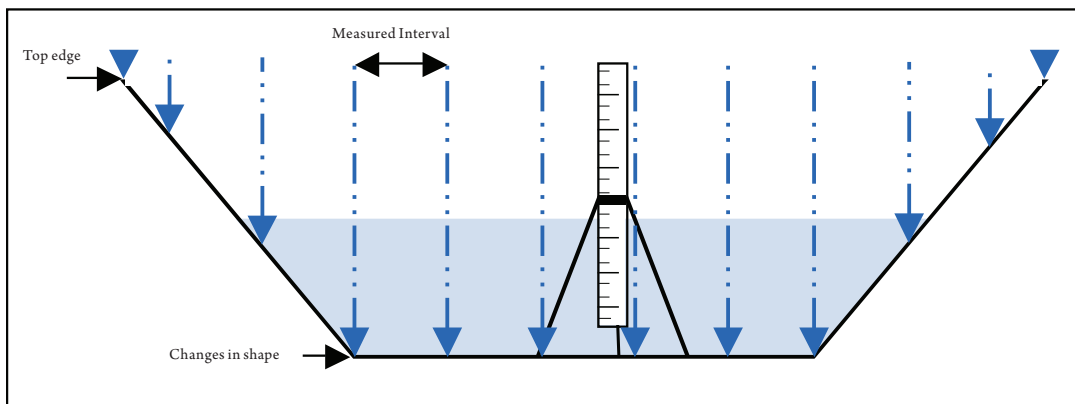

Figure 20. A basic survey method for determining the shape of the cross section by measuring the depth at marked intervals.



Figure 21.

Testing

After both dams have been built and the pond has been filled to the desired test level, inspect again and make sure any control structures are sealed. If additional leaks are found during the test, write down a description of them to help you with estimating water loss later.

The testing period is usually 24 to 48 hours, with time added at the beginning for the stabilization and saturation period. The staff gauge readings should be taken on a pre-determined schedule. However, you may need to adjust the schedule if it appears that the ponded segment will be empty before the end of the test. The exact time of each staff gauge reading should be recorded.

For each time interval, record the level for each staff gauge. Record the first staff gauge readings about 30 minutes after pretest preparations have been completed. The first set of readings probably will not be used for the final calculations, but will help you determine when the water level in the canal stabilizes. Continue taking readings every hour for the next 3 to 4 hours. This will help you determine the rate of loss during the canal's startup period.

During the following day(s), continue to take at least three readings per day and two readings at the end of the test. Tables 5 and 6 give suggested schedules for 24- and 48-hour test periods. In the appendix there is a Data Collection Form you can use to record staff gauge readings.

Tip: Starting the test early in the day will ensure that you have plenty of light to see the staff gauge markings.

Table 5. 48-hour test.

Reading		Time
Day 1	1	12:00
	2	13:00
	3	14:00
	4	15:00
Day 2	5	9:00
	6	12:00
	7	15:00
Day 3	8	9:00
	9	12:00

Table 6. 24-hour test.

Reading		Time
Day 1	1	12:00
	2	13:00
	3	14:00
	4	15:00
Day 2	5	8:00
	6	10:00
	7	12:00

Calculating Water and Seepage Loss Rates

Method 1 – basic shapes

To determine the loss rate from ponding tests, the wetted perimeters (WP) and the cross-sectional area (A) must be calculated using the appropriate equations shown in Figures 16-19. Note: For parabolic-shaped canals, WP and A can not be calculated directly, but must be done using a trial and error process. Or, search the Web for interactive calculators that perform these computations.

Step 1: Calculate the initial cross-sectional area (iA) using the appropriate equation (Figs. 16-19) based on canal shape. Use initial water depth (iD) in place of total depth (D).

Step 2: Calculate the final cross-sectional area (fA) using the appropriate equation based on canal shape. Use the final water depth (fD) reading in place of total depth (D).

Step 3: Calculate the rate of water loss in terms of gallons per day using this equation.

$$rWL = \frac{\text{Gal}}{\text{day}} = \frac{iA \times fA}{t \times 7.48}$$

Where:

iA = initial cross-sectional area

fA = final cross-sectional area

t = duration of test (hours)

7.48 = conversion factor

rWL = rate of water loss

Step 4: Calculate the wetted perimeter at the initial water depth (iD) reading.

Step 5: Calculate water loss in terms of volume per area (gallons per square foot per day) per linear foot of the canal.

$$\frac{\text{Gal}}{\text{ft}^2/\text{day}} = \frac{rWL}{iWP} \times 1 \text{ ft}$$

iWP = Initial Wetted Perimeter (ft)

Example:

A 600-foot long, trapezoidal, concrete canal section was selected and sealed for a ponding test. The dimensions of the cross section are as follows:

W = top width (10 ft)

B = bottom width (5 ft)

D = total depth (6 ft)

e = ? (The horizontal widths of the sides, which is usually needed for calculating the side slope, were difficult to measure, but side slope (Z) can be calculated using the equation in Step 1 below.)

The canal section was filled to normal operating level or initial depth (iD) of 5 feet. After 48 hours, the water depth had dropped by 0.5 feet, for a final depth (fD) of 4.5 feet.

Step 1: Calculate the side slope (Z) of the canal using the equation for a trapezoidal canal (Figs. 24 and 25).

$$Z = \frac{T - B}{2 \times D}$$

$$0.42 = \frac{10 \text{ ft} - 5 \text{ ft}}{2 \times 6 \text{ ft}}$$

Step 2: Calculate the total cross-sectional area (A) using

the trapezoidal equation.

$$A = B \times D + Z \times D^2$$

$$45 \text{ ft}^2 = 5 \text{ ft} \times 6 \text{ ft} + 0.42 \times 6^2 \text{ (ft)}$$

Step 3: Calculate the initial cross-sectional area (iA) using the starting water level or initial depth (iD) reading of the test using the trapezoidal equation.

$$iA = B \times iD + Z \times iD^2$$

$$35.42 \text{ ft}^2 = 5 \text{ ft} \times 5 \text{ ft} + 0.42 \times 5^2 \text{ (ft)}$$

iD = initial depth at the start of the test (5 ft)

iA = initial cross-sectional area

Step 4: Calculate the final cross-sectional area (fA) using the ending water level or final depth (fD) reading of the test using the trapezoidal equation.

$$fA = B \times fD + Z \times fD^2$$

$$30.94 \text{ ft}^2 = 5 \text{ ft} \times 4.5 \text{ ft} + 0.42 \times 4.5^2 \text{ (ft)}$$

fD = final depth at the end of the test

fA = final cross-sectional area

Step 5: Calculate the change in cross-sectional area (ΔA) during the test.

$$\Delta A = iA - fA$$

$$\Delta A = 35.42 \text{ ft}^2 - 30.94 \text{ ft}^2$$

$$\Delta A = 4.48 \text{ ft}^2$$

The change in area (ΔA) times 1 linear foot of the canal is the volume of water loss (vWL), or 4.48 ft³.

Step 6: Convert the volume of water loss (vWL), 4.48 ft³, to gallons of water loss.

$$vWL(\text{gal}) = vWL(\text{ft}^3) \times 7.48$$

$$WL_{\text{gal}} = 4.48 \text{ ft}^3 \times 7.48$$

$$WL_{\text{gal}} = 33.5 \text{ gal}$$

$$(1 \text{ ft}^3 = 7.48 \text{ gallon})$$

Step 7: Calculate rate of water loss (rWL) in terms of gallons per day. The total test time was 48 hours or 2 days (t = time).

$$rWL = \frac{vWL}{t}$$

$$rWL = \frac{33.5 \text{ gal}}{2 \text{ days}}$$

$$rWL = 16.75 \text{ gal/day}$$

Step 8: Calculate the wetted perimeter (WP) using the initial depth (iD) and using the wetted perimeter equation for a trapezoid.

$$WP = B + 2 \times iD \times (Z^2 + 1)^{0.5}$$

$$WP = 5 \text{ ft} + 2 \times 5 \text{ ft} \times (0.42^2 + 1)^{0.5}$$

$$WP = 15.83 \text{ ft}^2$$

Step 9: Calculate the rate of water loss (rWL) in terms of gallons per day per square foot.

$$rWL \text{ per ft}^2 = rWL \div WP$$

$$rWL \text{ per ft}^2 = 16.75 \text{ (gal/day)} \div 15.83 \text{ ft}^2$$

$$rWL \text{ per ft}^2 = 1.06 \text{ gal/ft}^2/\text{day}$$

Step 10: Calculate water loss in terms of acre feet per mile per year.

$$\frac{5,280 \text{ ft}}{\text{mile}} \times \frac{16.75 \text{ gal (rWL)}}{\text{day}} \times \frac{1 \text{ acre-foot}}{325,851 \text{ gal}} \times 365 \text{ days} = \frac{99.07 \text{ ac-ft/mile}}{\text{year}}$$

(325,851 gallons = 1 acre-foot)

Method 2 – irregular shapes

In calculating water loss from ponding tests, it is necessary to determine the wetted perimeter and the change in cross-sectional area during the test. In canals of irregular shape, the standard equations cannot be used. But there are several methods that can be used to determine these parameters.

One method is to graph the coordinates and then use graphic means to estimate the wetted perimeter and cross-sectional area. Another method is to fit an equation through the coordinates defining the canal's shape, and then integrate the equation to determine the area.

Corrections for Rainfall and Evaporation

If it rains during the test, rain gauges at the test site can be used to adjust the change in water level or ending depth for the amount of rainfall.

Loss to evaporation is usually insignificant and does not affect seepage loss rate, so it is usually ignored. To make this adjustment, pan evaporation or ETo (reference evapotranspiration, also written as "PET") rates can be used. However, the evaporation out of a canal will be less than either ETo or pan evaporation. Usually an adjustment factor of 0.6 to 0.8 is used depending on the size of the canal, the height of canal banks and similar factors.

Once the wetted perimeter and change in cross-sectional area are computed, the calculations are the same as given above. For more information, contact your county Extension office or your engineering consultant.

Field Guide for Performing a Ponding Test

Site Inspection and Preliminary Survey

1. Inspect the test segment by walking both sides to check for leaks from large holes or cracks, valves and gates. Mark leak locations with flags. Fill in with soil or seal if you determine that a leak is not representative of the test section (may require backhoe, shovels, and truck load of soil).
2. Set a flag marker at one of the locations where the earth dams will be built. With a measurement wheel, start from the flag and walk off the desired length of the test segment.
3. Determine the spacing of the staff gauges according to the test segment length.
4. Use the measurement wheel to place flag markers at the staff gauge locations.

Pre-test Procedures

5. Start building the downstream earth dam. Equipment required: backhoe, truck load(s) of soil.
6. Place staff gauges in the test segment. Equipment required: boat (for deep and wide canals), waders, staff gauges.
7. Survey the canal's cross sections at each staff gauge location and reference each staff gauge's height with the survey. Equipment required: transit and rod, or survey grade GPS unit. If the canal is too full for the survey, drain the canal and survey after the test has been completed.
8. Raise water in the test section to the desired level, usually to the normal or maximum operating water level.
9. Build the upstream earth dam. If you need to raise the water level after the dam has been built, use portable pumps.

Test Procedures

10. After filling the test segment, wait 30 minutes and take the first staff gauge readings and water span measurements.
11. Record the next water level measurements according to your schedule. Try to take each round of readings from the staff gauges within 2 minutes of the next (for example, 1:00 p.m., 2:02 p.m., 3:00 p.m., etc.).
12. Record the rain gauge level if rain has occurred.

Post-test Procedures

13. Drain the canal, removing the downstream dam first. If you still need to survey the cross-sections and staff gauges, drain the test segment slowly so the staff gauges won't be disturbed.
14. After surveying, remove the staff gauges and download any information from data loggers if electronic water level sensors were used.
15. Remove the upstream dam.

Equipment Checklist

Heavy machinery

- Backhoe
- Dump truck
- Portable gas-powered water pump
- Other
- Boat _____

Survey equipment

- Survey grade GPS equipment used to determine the cross-section of the canal
- Transit and rod
- Measurement wheel
- Stake or flag markers
- Measuring tape, non-metallic fiberglass (length 100 feet)

Electronics

- Laptop computer
- Water level sensors

Staff gauges and stands

Hand tools

Standard hand tools are used to install and maintain the testing equipment: drill, $\frac{1}{16}$ -inch drill bit, adjustable wrenches, rubber mallet, and standard and Philip's screw drivers.

Signs

Signs may be used around the test site area to warn people of danger and to inform them that testing is in progress. Signs may include a phone number, company, contact, and danger or warning labels.

Sample Ponding Test Data Form

Test ID	ID-97		Top width		15.77 feet (avg.)		
Canal	Lateral-11		Total depth		5.7 feet (avg.)		
Lining type	Geo liner/ shotcrete		Test length		802 feet		
			Survey type		GPS Survey-Grade		
Test type	Seepage						
Location	Off of 'I' Road, south of Military Hwy (281).						
Measurements: Staff gauge readings							
Date		SG1		SG2		SG3	
		Readings	Time	Readings	Time	Readings	Time
1	27-July	1.92	15:20	2.39	15:22	5.55	15:24
2		1.92	17:23	2.39	17:25	5.55	17:27
3	28-July	1.89	09:17	2.36	09:19	5.52	09:21
4		1.89	11:19	2.36	11:21	5.52	11:23
5		1.89	13:23	2.36	13:25	5.52	13:27
6		1.89	15:18	2.36	15:20	5.52	15:22
7	29-July	1.89	17:15	2.36	17:17	5.52	17:20
Water level adjustment	Staff gauge	True height	Staff gauge	True height	Staff gauge	True height	
	2.00	4.00	3.00	4.00	6.00	4.00	
Notes: Test segment has two major cracks.							

Ponding Test Data Form

(Make copies as needed.)

Test ID		Top width				
Canal		Total depth				
Lining type		Test length				
		Survey type				
Test type						
Location						
Measurements: Staff gage readings						
Date	SG__		SG__		SG__	
	Readings	Time	Readings	Time	Readings	Time
1						
2						
3						
4						
5						
6						
7						
Water level adjustment	Staff gauge	True height	Staff gauge	True height	Staff gauge	True height
Notes:						

References

- Canessa, P. 2001. Development of a Rapid Seepage Assessment Vehicle. Independent Consultant.
- Christopher, J. N. 1981. Comments on canal seepage measuring and estimating procedures. Prepared for World Bank Seminar.
- Conservation Verification Consultants. 1996. Project 2, 5, 10, 11, 16, and 7 main and lateral canal concrete lining verification summary report.
- DeMaggio, 1990. Technical Memorandum: San Luis unit drainage program project files. U.S. Bureau of Reclamation, Sacramento.
- District Management System Program. 2000. Canal ponding test results for 1999-2000. Agricultural Engineering Department, Texas A&M University.
- Engelbert, P. J., R. H. Hotchkiss and W. E. Kelly. 1997. Integrated remote sensing and geophysical techniques for locating canal seepage in Nebraska. *Journal of Applied Geophysics*. 38:143-154.
- Nayak, et al. 1996. The influence of canal seepage on groundwater in Lugert Lake irrigation area. Oklahoma Water Resources Research Institute.
- Nofziger, 1979. Profit potential of lining watercourses in coastal commands of Orissa. *Environment and Ecology* 14(2):343-345.
- Robinson, A. R. and C. Rohwer. 1959. Measuring seepage from irrigation channels. USDA ARS Technical Bulletin No. 1203.
- Schwab, G.O., D.D. Fangmeier and W.J. Elliot. 1996. Soil and Water Management System, 4th ed. New York: John Wiley and Sons, Inc.
- U.S. Bureau of Reclamation, 1961. Measuring seepage loss in irrigation canals. Hydraulic Laboratory Report HYD-459.
- U.S. Bureau of Reclamation, 1963. Lining for Irrigation Canals.

Reports for completed ponding tests are posted at <http://idea.tamu.edu>.

Produced by AgriLife Communications, The Texas A&M System
Extension publications can be found on the Web at: <http://AgriLifeBookstore.org>.
Visit Texas AgriLife Extension Service at <http://AgriLifeExtension.tamu.edu>.

Educational programs of the Texas AgriLife Extension Service are open to all people without regard to race, color, sex, disability, religion, age, or national origin.

Issued in furtherance of Cooperative Extension Work in Agriculture and Home Economics, Acts of Congress of May 8, 1914, as amended, and June 30, 1914, in cooperation with the United States Department of Agriculture. Edward G. Smith, Director, Texas AgriLife Extension Service, The Texas A&M System.

400, New